

C5604-1200



- ▶ Designed mainly for industries handling food, chemical and pharmaceutical products.
- ▶ Solution that contributes to dust-free conveying.
- ▶ All materials in contact with the conveyed product fulfil the requirements of FDA, USDA and 3-A.
- ▶ Turnkey conveyor that is easy to install and start up.
- ▶ Manual dismounting and cleaning.
- ▶ Low sound level.
- ▶ Fully pneumatic.

Technical data

Description	Unit	Value
Feed pressure range	MPa	0.4–0.6
Air consumption range	NI/s	60–84
Vacuum range	-kPa	61–75
Noise level range	dBA	72–76
Temperature range	°C	0–60
Safety classification		IP54
Material batch volume	l	72.3
Min. particle size	µm	5.0

Capacity

Capacity ton/h at different conveying distances			
5 m	10 m	20 m	30 m
10.80	5.40	2.70	1.80

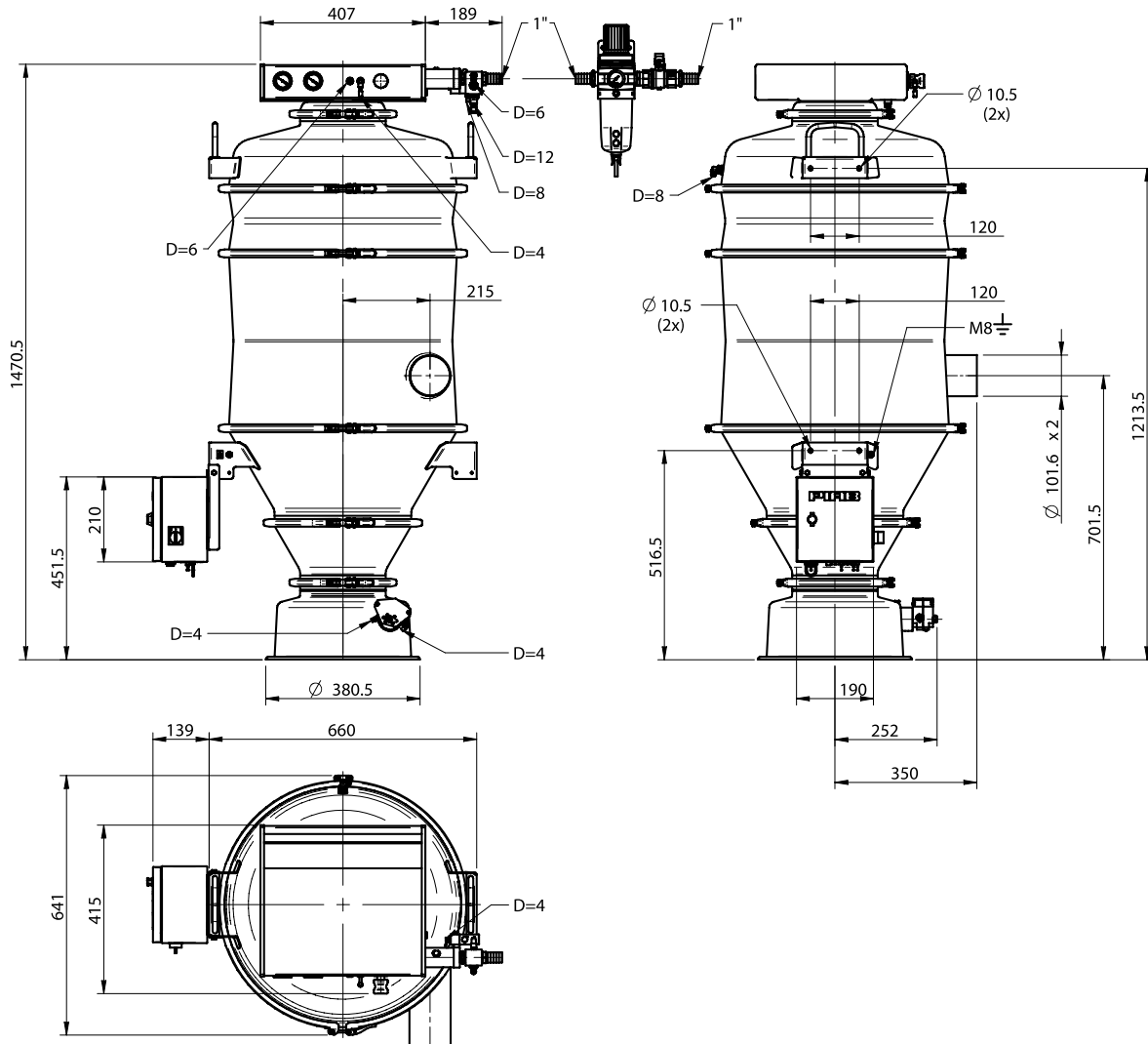

Complete